

COMMUNICATION CAMERA

# VC-C4 / VC-C4R

## INSTRUCTION MANUAL

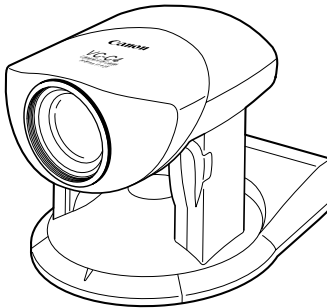

VC-C4

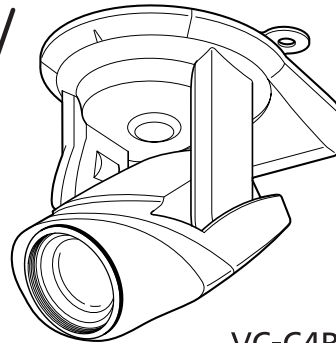

VC-C4R

Please read this instruction manual carefully before operation.  
Be sure to read the “ Safe Use of Equipment” section before using this equipment. Store this manual in a readily accessible location for future reference.

# Introduction

Thank you for purchasing the Canon Communication Camera VC-C4/VC-C4R (the “Product”).

Please read this Instruction Manual carefully to ensure that you use the Product correctly and safely. Read the “△ Safe Use of Equipment” section first and observe these instructions when you use the Product.

## Features of the VC-C4/VC-C4R Communication Camera

- 1/4 inch CCD, 410,000 pixels (NTSC) or 470,000 pixels (PAL) for high-quality images
- High-performance 16× power zoom
- Wide angle photographic range
- High-speed precision camera head movement
- Preset function (programmable presets can be stored in camera’s memory)
- Camera ID setting
- Clock and text display function
- Up to 9 VC-C4/VC-C4R cameras can be controlled from 1 PC

### Exclusion of Liability

If the Product is connected to a recording device (for example a VCR), Canon Inc. accepts no responsibility whatsoever for any financial losses that may be incurred as a result of the loss of recorded information or images, regardless of the internal or external cause of the loss.

## Copyright Information

Video or still images recorded using your VC-C4/VC-C4R cannot be used in ways that infringe copyright laws or without the consent of the owner, unless intended for personal use only.

## Notes

1. The unauthorized transfer of all or any part of the contents of this Manual is forbidden.
2. The contents of this Manual are subject to change without notice.
3. Every effort has been made to ensure that this Manual is flawless. However, if you find any oversights, please let us know.
4. Item 3. notwithstanding, Canon accepts no responsibility for any effects resulting from the use of this Manual.

CANON and the CANON logo are registered trademarks of Canon Inc. Other names of products and companies mentioned in this Manual are trademarks or registered trademarks of the respective companies.

# Safe Use of Equipment



An exclamation point, within a triangle, is intended to alert the user to the presence of important operating and maintenance (servicing) instructions in the literature accompanying the equipment.

## **1** Important Warnings

### **CAUTION:**

**TO REDUCE THE RISK OF ELECTRIC SHOCK, DO NOT REMOVE COVER (OR BACK). NO USER-SERVICEABLE PARTS INSIDE. REFER SERVICING TO QUALIFIED SERVICE PERSONNEL.**

The serial number of this equipment may be found on the back of the camera head. No others have the same serial number as yours.

You should record the number and other vital information here and retain this book as a permanent record of your purchase to aid identification in case of theft.

**Date of Purchase**

**Dealer Purchased from**

**Dealer Address**

**Dealer Phone No.**

**Model No.** VC-C4 or VC-C4R

**Serial No.**

## **2** Important Operational Instructions

### **WARNING:**

**TO REDUCE THE RISK OF ELECTRIC SHOCK, DO NOT EXPOSE THIS EQUIPMENT TO RAIN OR MOISTURE.**

### **CAUTION:**

**TO REDUCE THE RISK OF ELECTRIC SHOCK AND TO REDUCE ANNOYING INTERFERENCE, USE THE RECOMMENDED ACCESSORIES ONLY.**

#### **FDA regulation**

This communication camera has not been evaluated by the Food and Drug Administration (FDA) for use as a medical device. When incorporated into a system with medical applications, FDA regulations may apply. Therefore, please consult your legal advisor to determine whether FDA regulations apply.

### FCC NOTICE

PT-V4N/PT-V4NR

This device complies with Part 15 of the FCC Rules. Operation is subject to the following two conditions: (1) This device may not cause harmful interference, and (2) this device must accept any interference received, including interference that may cause undesired operation.

**Note:** This equipment has been tested and found to comply with the limits for a Class B digital device, pursuant to Part 15 of the FCC Rules. These limits are designed to provide reasonable protection against harmful interference in a residential installation. This equipment generates, uses and can radiate radio frequency energy and, if not installed and used in accordance with the instructions, may cause harmful interference to radio communications.

However, there is no guarantee that interference will not occur in a particular installation. If this equipment does cause harmful interference to radio or television reception, which can be determined by turning the equipment off and on, the user is encouraged to try to correct the interference by one or more of the following measures:

- Reorient or relocate the receiving antenna.
- Increase the separation between the equipment and receiver.
- Connect the equipment into an outlet on a circuit different from that to which the receiver is connected.
- Consult the dealer or an experienced radio/TV technician for help.

Use of shielded cable is required to comply with class B limits in Subpart B of Part 15 of FCC Rules.

Do not make any changes or modifications to the equipment unless otherwise specified in the manual. If such changes or modifications should be made, you could be required to stop operation of the equipment.

Canon U.S.A. Inc.

One Canon Plaza, Lake Success, NY 11042, U.S.A.

Tel No. (516) 328-5600

### IC NOTICE

This product does not exceed the Class B limits for radio noise emissions from digital apparatus as set out in the Interference-causing equipment standard entitled 'Digital Apparatus', ICES-003 of the Industry Canada.

### 3 IMPORTANT SAFETY INSTRUCTIONS

In these safety instructions, the word “equipment” refers to the Canon communication camera VC-C4/VC-C4R and all its accessories.

1. Read Instructions - All the safety and operating instructions should be read before the equipment is operated.
2. Retain Instructions - The safety and operating instruction should be retained for future reference.
3. Heed Warnings - All warnings on the equipment and in the operating instructions should be adhered to.
4. Follow Instructions - All operating and maintenance instructions should be followed.
5. Cleaning - Unplug this equipment from the wall outlet before cleaning.

Wipe the equipment with a clean soft cloth. If necessary, put a cloth in diluted neutral detergent and wring it well before wiping the equipment with it. Finally, clean the equipment with a clean dry cloth. Do not use benzene, thinner or other volatile liquids or pesticides as they may damage the product’s finish. When using chemically-treated cleaning cloths, observe those precautions accordingly.

6. Accessories - Do not use accessories not recommended in this manual as they may be hazardous. Always use specified connection cables. Connect devices correctly.
7. Water and Moisture - Hazard of electric shock - Do not use the equipment near water or in rainy/moist situations. Do not put a heater near this equipment.
8. Placing or Moving - Do not place on an unstable cart, stand, tripod, bracket or table. The equipment may fall, causing serious injury to a child or adult, and serious damage to



the equipment. An equipment and cart combination should be moved with care. Quick stops, excessive force, and uneven surfaces may cause the equipment and cart combination to overturn.

9. Power Sources - The PA-V16 AC adapter should be operated only from the type of power source indicated on the marking label. If you are not sure of the type of power supply to your home, consult your equipment dealer or local power company. Regarding other power sources such as battery power, refer to instructions in this manual.
10. Polarization - The PA-V16 AC adapter is equipped with a polarized 2-prong plug (a plug having one blade wider than the other). The 2-prong polarized plug will fit into the power outlet only one way. This is a safety feature. If you are unable to insert the plug fully into the outlet, try reversing the plug. If the plug still fails to fit, contact your electrician to replace your obsolete outlet. Do not defeat the safety purpose of the polarized plug.
11. Power Cord Protection - Power cords should be routed so that they are not likely to be walked on or pinched by items placed upon or against them. Pay particular attention to plugs and the point from which the cords exit the equipment.
12. Outdoor Antenna Grounding - If an outside antenna is connected to the equipment, be sure the antenna is grounded so as to provide some protection against voltage surges and built-up static charges. Section 810 of the National Electrical Code, ANSI/NFPA No.70-1984, provides information with respect to proper grounding of the mast and supporting structure, grounding of the lead-in wire to an antenna discharge unit, size of grounding conductors, location of

antenna discharge unit, connection to grounding electrodes, and requirements for the grounding electrode. See figure 1.

fig-1

EXAMPLE OF ANTENNA GROUNDING AS PER NATIONAL ELECTRICAL CODE

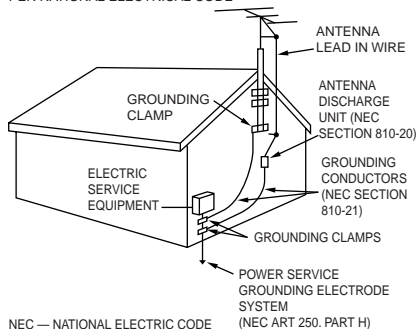

NEC — NATIONAL ELECTRIC CODE (NEC ART 250, PART H)

13. Lightning - For added protection of this equipment during a lightning storm, or when it is left unattended and unused for long periods of time, disconnect it from the wall outlet and disconnect the antenna. This will prevent damage to the equipment due to lightning and power-line surges.
14. Power Lines - An outside antenna system should not be located in the vicinity of overhead power lines or other electric light or power circuits, or where it can fall into such power lines or circuits. When installing an outside antenna system, extreme care should be taken to keep from touching such power lines or circuits as contact with them might be fatal.
15. Overloading - Do not overload wall outlets and extension cords as this can result in a risk of fire or electric shock.
16. Object and Liquid Entry - Never push objects of any kind into this equipment through openings as they may touch dangerous voltage points or short out parts that could result in a fire or electric shock. Be careful not to spill liquid of any kind onto the equipment.
17. Servicing - Do not attempt to service this equipment yourself as opening or removing covers may expose you to dangerous voltage or other hazards. Refer all servicing to qualified personnel.
18. Damage Requiring Service - Disconnect this equipment from the wall outlet and all power sources including batteries, and refer servicing to qualified service personnel under the following conditions.
  - a. When the power-supply cord or plug is damaged.
  - b. If any liquid has been spilled onto, or objects have fallen into, the equipment.
  - c. If the equipment has been exposed to rain or water.
  - d. If the equipment does not operate normally even if you follow the operating instructions. Adjust only those controls that are covered by the operation instructions. Improper adjustment of other controls may result in damage and will often require extensive work by a qualified technician to restore the equipment to its normal operation.
  - e. If the equipment has been dropped or the cabinet has been damaged.
  - f. When the equipment exhibits a distinct change in performance. This indicates a need for service.
19. Replacement Parts - When replacement parts are required, be sure the service technician has used replacement parts that are specified by Canon or that have the same characteristics as the original part. Unauthorized substitutions may result in fire, electric shock or other hazards.
20. Safety Check - Upon completion of any service or repairs to this equipment, ask the service technician to perform safety checks to determine that the equipment is in safe operating order.

21. Do not install the equipment in the following locations as this can cause a fire or electric shock:
  - Hot locations
  - Close to a fire
  - Very humid or dusty locations
  - Locations exposed to direct sunlight
  - Locations exposed to salt spray
  - Close to flammable solvents (alcohol, thinners, etc.)
22. When any of the following occurs, immediately switch OFF the equipment, unplug it from the main power supply and contact your nearest Canon supplier. Do not continue to use the equipment as this can cause a fire or electric shock.
  - The equipment emits any smoke, heat, abnormal noise, or unusual odor.
  - A metal object falls into the equipment.
  - The equipment is damaged in some way.
23. Please observe the following when using the equipment. Failure to do so can result in a fire or electric shock.
  - Do not use flammable sprays near the equipment.
  - Do not subject the equipment to strong impacts.
24. Please observe the following when handling the batteries. Failure to do so can result in the batteries bursting or emitting heat, sparks or corrosive fluid.
  - Do not throw the batteries into a fire, and do not heat, short-circuit or attempt to disassemble the batteries.
  - Do not attempt to recharge the batteries.
  - Do not use batteries other than those specified for use with the equipment.
25. Please observe the following when handling the batteries. Failure to do so may result in the batteries bursting or emitting heat, sparks or corrosive fluid.
  - When the batteries are used up, or when the equipment will not be used for an extended period, remove the batteries.
  - When replacing the batteries, always replace both batteries, and do not use different types of batteries together.
  - Ensure that the + and - terminals are correctly positioned when you load the batteries.
  - If any soiling or leakage of the internal battery fluid occurs, thoroughly clean the soiling or leaked fluid with water.

## 4 Maintenance

### Cleaning the Equipment

1. Unplug the AC adapter from the wall outlet.
2. Carefully wipe the equipment with a soft cloth that has been moistened with water or a mild detergent.

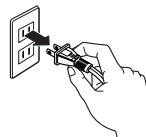

### ! WARNING

**Do not use flammable solvents such as alcohol, benzene or thinners.**

The use of such substances can cause a fire or electric shock.

3. Wipe with a dry cloth.
4. When you have finished, plug the AC adapter back in to the wall outlet.

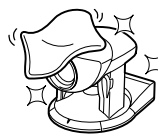

### Cleaning the Lens

Use a commercially available lens cleaner to remove any soiling from the lens.

- The auto-focus may not function correctly if the surface of the lens is dirty.
- Scratches on the surface of the lens will cause image defects.

### Icons Used in This Instruction Manual



Indicates important information that must be observed or actions that are prohibited during an operation. These notes must be read to prevent possible faults or damage to the equipment.



Indicates supplementary information or a reference to an operation. Users are advised to read these memos.



# CONTENTS

<b>⚠ Safe Use of Equipment .....</b>	<b>3</b>
<b>1 ⚠ Important Warnings .....</b>	<b>3</b>
<b>2 ⚠ Important Operational Instructions .....</b>	<b>3</b>
<b>3 ⚠ IMPORTANT SAFETY INSTRUCTIONS .....</b>	<b>5</b>
<b>4 Maintenance .....</b>	<b>8</b>
<b>Icons Used in This Instruction Manual .....</b>	<b>8</b>
<b>Before You Use the Product .....</b>	<b>10</b>
<b>1 Checking the Accessories .....</b>	<b>10</b>
<b>2 Nomenclature .....</b>	<b>10</b>
Camera .....	10
Wireless Controller .....	11
<b>3 Installing the Product .....</b>	<b>12</b>
<b>4 Connecting the Components .....</b>	<b>13</b>
<b>5 Turning the Power ON and OFF .....</b>	<b>14</b>
LED Displays and the Camera Status .....	14
<b>6 Loading the Batteries into the Wireless Controller .....</b>	<b>15</b>
Operable Range of the Wireless Controller .....	15
<b>Controlling the Camera from the Wireless Controller .....</b>	<b>16</b>
<b>1 Changing the Camera Head Angle (pan/tilt/home position) .....</b>	<b>16</b>
Range of Camera Head Movement .....	16
<b>2 Zooming In/Out (TELE/WIDE) .....</b>	<b>17</b>
<b>3 Focusing (FOCUS) .....</b>	<b>18</b>
<b>4 Adjusting the Brightness (BRIGHT) .....</b>	<b>19</b>
<b>5 Storing a Preset Camera Position .....</b>	<b>20</b>
<b>6 Switching the Camera ON and OFF .....</b>	<b>21</b>
<b>Camera Settings .....</b>	<b>22</b>
<b>1 Buttons Used to Specify the Settings .....</b>	<b>22</b>
Setting Menu Description .....	22
<b>2 Setting the Clock .....</b>	<b>23</b>
<b>3 Entering Characters .....</b>	<b>24</b>
<b>4 Selecting Display/Hide Clock and Text .....</b>	<b>24</b>
<b>5 Setting the Camera Head Movement Speed and Pan Operation .....</b>	<b>25</b>
<b>6 Setting the Range of Camera Head Movement .....</b>	<b>26</b>
<b>7 Setting the AE .....</b>	<b>27</b>
<b>8 VC-C1 Mode and VC-C3 Mode Setting Menu .....</b>	<b>27</b>
<b>9 RS-232C Settings .....</b>	<b>28</b>
<b>ID Mode .....</b>	<b>29</b>
<b>1 Setting the ID Number .....</b>	<b>29</b>
<b>2 Selecting the Camera to be Controlled .....</b>	<b>30</b>
<b>3 Cancelling ID Mode .....</b>	<b>31</b>
<b>Troubleshooting .....</b>	<b>32</b>
<b>Factory Default Settings .....</b>	<b>34</b>
<b>Specifications .....</b>	<b>35</b>
<b>Appendix A .....</b>	<b>36</b>

# Before You Use the Product

## 1 Checking the Accessories

Before you install the Product, check that all the items shown below are included in your product package. If any of these items is missing, contact your Canon dealer.

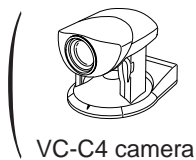

or

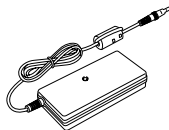

- 2 AA-size manganese batteries
- Instruction Manual
- Warranty Card

### ■ Optional Product

- **Wide-angle Converter WL-37**

Cannot be used on the VC-C4R (→ P.13).

## 2 Nomenclature

### Camera

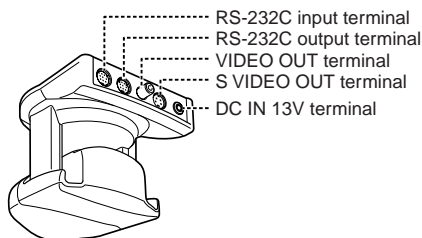
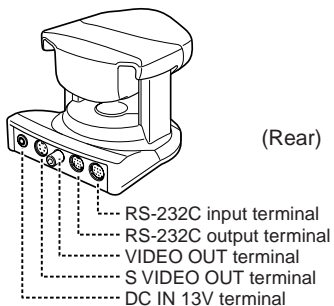
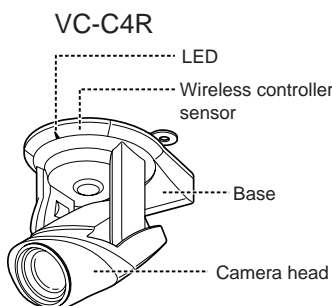
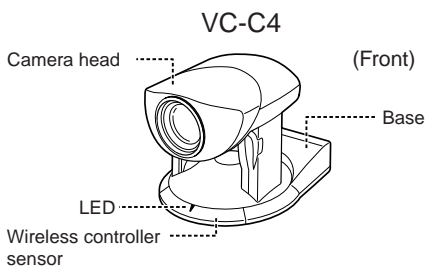

## Wireless Controller

### BRIGHT button (→ P.19)

Adjusts the brightness of the image on the monitor.

- + : Brightens the image.
- - : Darkens the image.

### SET/OK button (→ P.20, 22)

Used to store preset positions. Can also be used to proceed to the next level when specifying settings in a setting menu.

### FOCUS button (→ P.18, 19)

Adjusts the focus.

- AF : Switches to auto-focus.
- MF : Focus is fixed.
- ▲ : Lengthens the focal distance.
- ▼ : Shortens the focal distance.

### ON SCREEN button (→ P.24)

Displays or hides the date, time and text.

### Fn button

Not used.

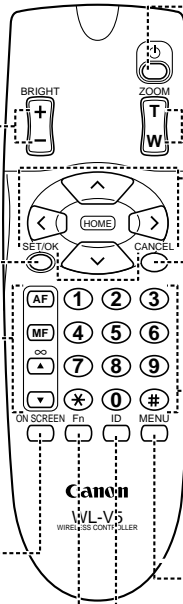

### Camera ON/OFF button (→ P.21)

Switches the camera on and off.

### ZOOM button (→ P.17)

Increases or decreases the size of the subject on the monitor screen.

- T : Enlarges the subject (zoom in).
- W : Shrinks the subject (zoom out).

### Camera control button (→ P.16, 22)

Used to change the camera head angle and to move the on-screen cursor.

- ▲ ▼ < > : Move the camera head up, down, left and right respectively.
- HOME : Moves the camera head to the center.

### CANCEL button (→ P.20, 22)

Cancels registration of a preset camera position. Also cancels a setting selected in a setting menu and returns you to the previous level.

### Number buttons (→ P.20, 30)

Used to store and restore preset positions, and to select the camera when multiple cameras are used. The ⊕ and ⊖ buttons are not used.

### MENU button (→ P.22)

Used to display the MAIN MENU and to exit a setting menu.

### ID button (→ P.30)

Used to control multiple cameras individually. When the cameras are switched off, pressing this button begins individual camera control.

### Battery cover

See page 15 for information on loading the batteries.

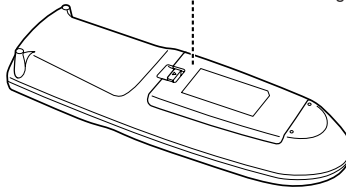

Whenever possible, switch the camera off when it is not in use (→ P.21) as this reduces power consumption. If the camera will not be used for an extended period, unplug the AC adapter from the wall outlet (→ P.14). If you turn the power off, the date and time will be cleared.

### 3 Installing the Product

#### VC-C4 Installation

Install in a flat and stable location.

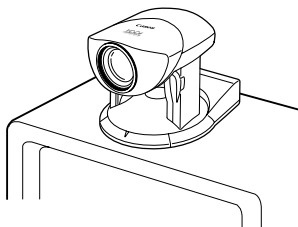

#### VC-C4R Installation

Firmly tighten the 2 screws (not supplied).

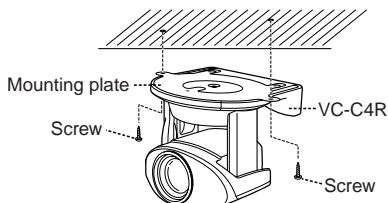

(Installation)

- Distance between tapped holes: 114 mm (4 1/2 in.)
- Tapped hole diameter: 6 mm (1/32 in.)
- Mounting plate thickness: 1 mm (1/16 in.)

## ! WARNING

Install the camera securely.

- **When installing the camera on the ceiling, contact your Canon dealer.**
- When installing the camera on the ceiling, check that the ceiling is strong enough to bear the weight of the camera including the installation bracket. Installation in a weak location could result in the camera falling and causing serious injury.
- At least once a year, check for looseness in the camera installation mount. (If the optional wide-angle converter is used, check the converter mount also.)



NOTE

The permissible camera installation angles are  $\pm 20^\circ$  from the horizontal. ( $\pm 15^\circ$  when the optional wide-angle converter is used.)

### Using a Tripod

The screw mount for a tripod is located in the center of the underside of the camera.



NOTE

- **Do not overtighten the mounting screw.** If excessive force is used to tighten the mounting screw, camera head movement may be impeded, or other malfunctions may result.
- Always use a tripod mounting screw that is less than 6.0 mm (1/4 in.) in length. The use of screws 6.0 mm (1/4 in.) long or longer could damage the camera. Also, the tripod seat used should be at least 30 mm (1 3/16 in.) in diameter.

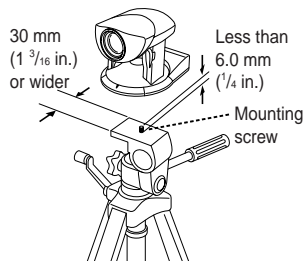

## Using the Wide-angle Converter

The optional Wide-angle Converter WL-37 can be used to provide wide-angle shots (approx. 0.74× the normal focal distance).

Mount the wide-angle converter correctly so that it is level and fitted securely onto the camera. When mounted correctly, the wide-angle converter should turn roughly 3 times before stopping.

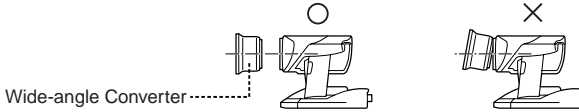

### ⚠ WARNING

The Wide-angle Converter WL-37 is designed specifically for the VC-C4 and cannot be used on the VC-C4R. If the converter is used on the VC-C4R, the mount will gradually loosen and the converter will fall off the camera.



- The camera may not operate correctly if a wide-angle converter other than the WL-37 is used.
- The permissible range of camera installation angles with the wide-angle converter mounted on the camera is  $\pm 15^\circ$  from the horizontal.

## 4 Connecting the Components

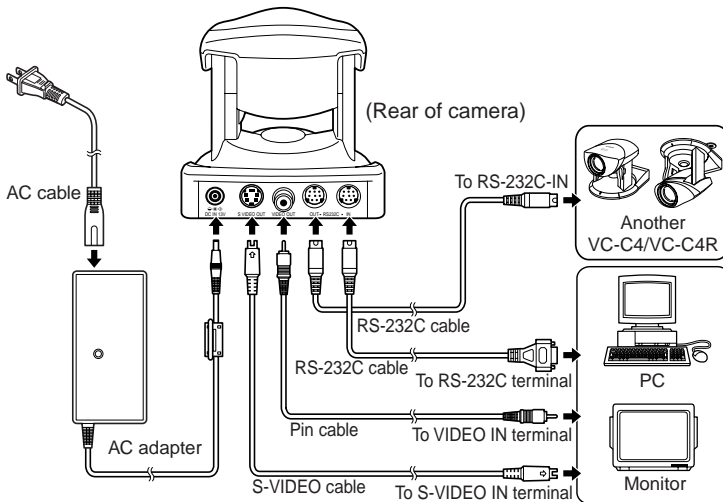

No S-VIDEO or RS-232C cable is supplied with the camera. Consult your dealer for information on suitable RS-232C cables for your computer.

## 5 Turning the Power ON and OFF

The VC-C4/VC-C4R camera itself does not have a power switch. You can switch the camera on by plugging the AC adapter into a wall outlet. When power to the camera is switched on, the LED on the camera turns green. If the monitor is switched on, an image appears on the screen.

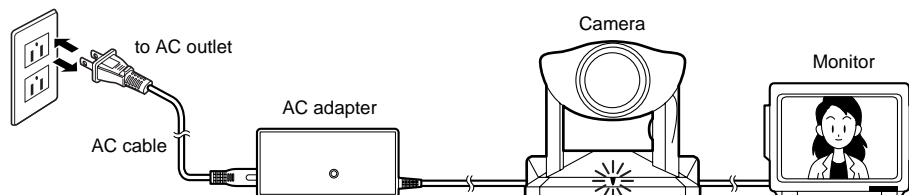

NOTE

- **Whenever you turn the power on, first press any button on the wireless controller.** This initializes the camera head position. Initialization takes several seconds. During initialization, the LED on the camera flashes green (at 1-second intervals).
- Never touch the camera head during initialization as this could prevent successful initialization and cause faults.
- Wait at least five seconds before turning the power back on after shutting it off. Turning it on too quickly may result in a malfunction. Observe the precautions given in “△ Safe Use of Equipment/△ IMPORTANT SAFETY INSTRUCTIONS” (→ P.5–7).

### LED Displays and the Camera Status

LED Display		Camera Status
Green		Camera is on. (→ P.21)
Blinking green	At 0.1-sec. intervals	Wireless controller button being used.
	At 0.5-sec. intervals	Storing or restoring a preset (→ P.20), or displaying a setting menu. (→ P.22)
	At 1-sec. intervals	Camera head position initialization in progress.
Orange		Individual camera operation in progress and this camera is not selected. (→ P.30)
Blinking orange	At 0.1-sec. intervals	Camera is not selected for individual operation and is being controlled from the wireless controller. (→ P.30)
	At 0.5-sec. intervals	The camera is being selected or deselected for individual operation. (→ P.30)
Red		Camera is off. (→ P.21)
Off		Power is off.

## 6 Loading the Batteries into the Wireless Controller

The wireless controller requires two AA-type batteries.

### 1. Remove the battery cover.

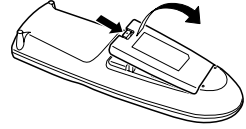

### 2. Insert the batteries.

- Taking care that the poles (+ and -) are correctly positioned.

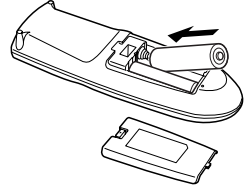

### 3. Replace the battery cover.

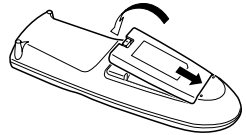

## ⚠ WARNING

Observe the following precautions when handling batteries.

Failure to do so could result in the batteries bursting or emitting heat, sparks or corrosive fluid.

- Do not throw the batteries into a fire, and do not heat, short-circuit or attempt to disassemble the batteries.
- Do not attempt to recharge the batteries.

## Operable Range of the Wireless Controller

Use the wireless controller within the range described below, facing it toward the sensor for the wireless controller. The operable range of the wireless controller varies depending on the amount of charge remaining in the batteries and interference from other objects. (This applies equally to the VC-C4R.)

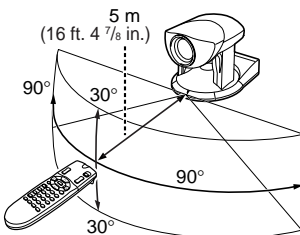

# Controlling the Camera from the Wireless Controller

While the wireless controller buttons are being used, the LED on the camera blinks green (at 0.1-second intervals) (→ P.14).

## 1 Changing the Camera Head Angle (pan/tilt/home position)

Use the procedures below to change the camera head angle.

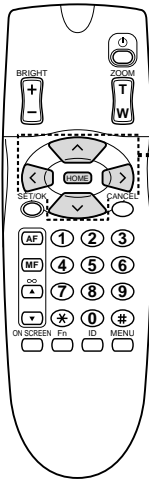

### To move the camera head left and right (pan)

Press the and buttons.

- When pointing the remote control in the direction of the camera and using it, the image on the monitor moves in the direction of the arrow on the button pressed, and the camera head moves in the opposite direction.

When DIRECTION MIRROR (→ P.25) is set to ON, the camera head moves in the direction of the arrow on the button pressed.

- Holding the button down increases the speed of camera head movement as shown below.  
Low speed → Medium speed → High speed

### To move the camera head up and down (tilt)

Press the and buttons.

- Holding the button down increases the speed of camera head movement as shown below.  
Low speed → Medium speed → High speed

### To move the camera head to the Home position

Press the button.

- This moves the camera head to the center position at high speed.



### Do not attempt to manually change the camera head angle.

If the camera head is accidentally moved, either by hand or by being struck by an object, always press the button. The deviation from the position that the camera memorizes will be corrected and the operation will be back in order.



## Range of Camera Head Movement

The figures below show the range of camera head movement from a horizontal position. The default range of upward movement for the VC-C4 is 30°, but the range can be set to 90° (→ P.26).

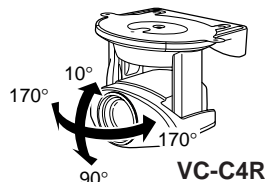
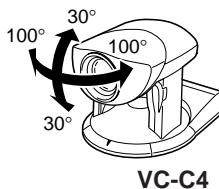



## 2 Zooming In/Out (TELE/WIDE)

The zoom function increases (zoom in) and decreases (zoom out) the size of the subject on the monitor screen.

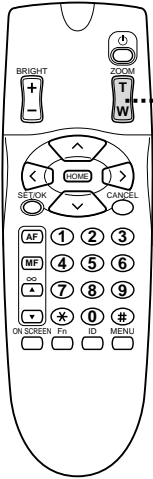

### To zoom in (TELE):

Press the **T** side of the button.

- Holding down the button changes the rate of zoom as shown below.

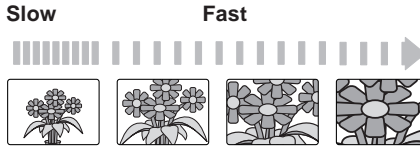

### To zoom out (WIDE):

Press the **W** side of the button.

- Holding down the button changes the rate of zoom as shown below.

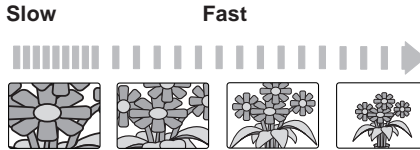

### Focusing Range

At some zoom settings, the camera may not be able to focus on the subject.

#### Changes in the distance from the camera to the subject

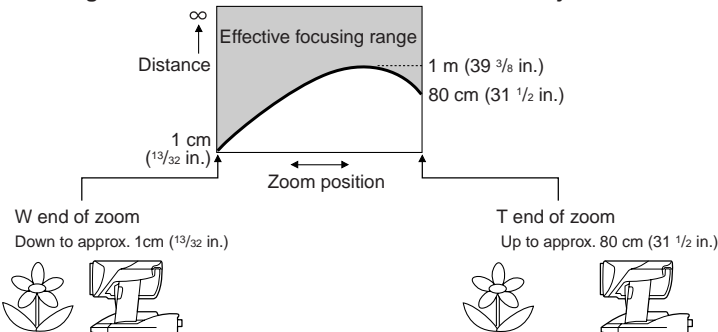

### 3 Focusing (FOCUS)

This section describes how to focus on the subject. The VC-C4/VC-C4R has an auto-focus mode, in which the camera automatically focuses on the subject, and a manual focus mode, in which the operator can adjust the focus by hand.

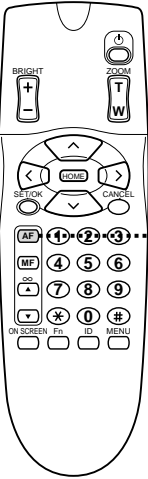

#### To use autofocus mode

Press the **(AF)** button.

- The camera focuses automatically.



#### Subjects not suitable for auto-focus

The camera may have difficulty focusing automatically on subjects of the type shown below. Use the manual focus mode for such situations.



Subjects with little or no contrast (a white wall, for example)

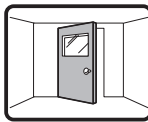

Angled subjects



Highly reflective subjects

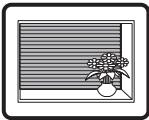

Horizontally striped subjects

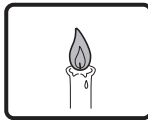

Insubstantial subjects such as flames or smoke

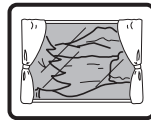

Subjects seen through glass

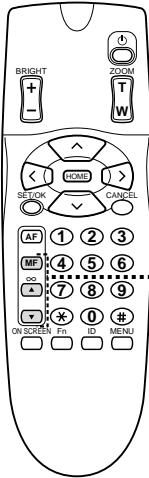

### To fix the focus

Press the **MF** button.

- This switches auto-focus off and fixes the focus.

### To focus on nearby subjects

Press the **MF** button.

- This enables switching the camera to manual focus mode while moving the focal point closer to the camera.
- Holding the button down moves the focal point closer to the camera.

### To focus on distant subjects

Press the **MF** button.

- This enables switching the camera to manual focus mode while moving the focal point further from the camera.
- Holding the button down moves the focal point further away from the camera.
- At some zoom settings, the camera may not be able to focus on the subject (→ P.17).

## 4 Adjusting the Brightness (BRIGHT)

This function brightens or darkens the image on the monitor. When the camera is switched on, the brightness is set to the Normal level.

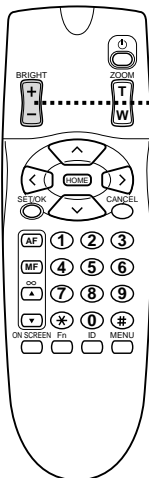

### To brighten or darken the image

Press the **+** side of the button to brighten the image and the **-** side to darken the image.

- The image gradually brightens (or darkens) while the button is held down.

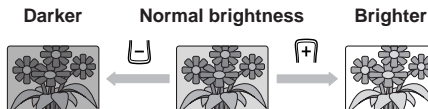

- The Normal brightness setting corresponds to setting [5] in the AE REFERENCE screen (→ P.27). The brightest setting is [10] and the darkest setting is [1].
- It may not be possible to adjust the brightness when the area around the subject is extremely dark. In this event, use lighting to brighten the area around the subject.

## 5 Storing a Preset Camera Position

This section describes how to store a camera head angle, zoom position and brightness level. Up to nine (1 to 9) preset positions can be stored. Switching the power off or the camera off does not erase the stored preset positions.

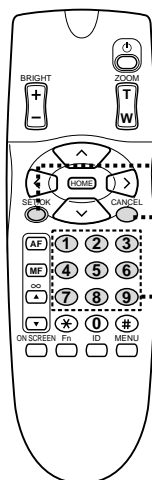

### To store a position

#### 1. Set the camera head angle, zoom position and brightness.

- The focus setting is not stored.

#### 2. Press the button.

- The LED on the camera blinks green (at 0.5-second intervals).
- Press the  button again to cancel the operation.

#### 3. Press a button from to .

- When the position has been stored, the LED on the camera stops blinking and remains green.
- Any existing preset information is overwritten.

### To restore a preset position

#### Press a button from to .

- The VC-C4/VC-C4R returns to the stored camera head angle, zoom position and brightness level.



MEMO

- During preset operations, the camera pans and tilts at the speeds set for pan/tilt operation in the setting menu. When the "AUTO" setting is selected, the head moves at the maximum speed (→ P.25).
- Stored preset position information can only be overwritten. Stored preset positions cannot be erased. However, the preset position is cleared if the COMMAND mode is changed.
- If the camera is in manual focus mode, the focus may be incorrect when a preset position is restored. In this event, set the camera to auto-focus mode or focus the camera manually.

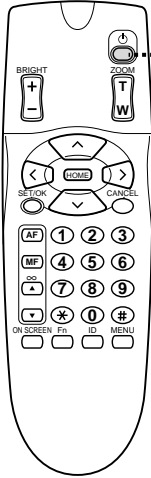

## 6 Switching the Camera ON and OFF

The camera is switched on and off by using the  (camera ON/OFF) button on the wireless controller.



### To switch the camera off

With the wireless controller in range of the camera, press the  button.

- The image disappears and the LED on the camera turns red (camera OFF). The camera will now respond only to the  button or  button on the wireless controller.

### To switch the camera on

In the status of camera OFF, press the  button.

- An image appears on the monitor screen and the LED on the camera turns green (camera ON). The camera will now respond to all operations performed from the wireless controller.
- Even if the camera is off, when you press the  button the LED on the camera blinks orange and you can begin ID mode operation (→ P.30).



- Even if you switch the camera off, electric current will continue to flow to the camera. However, the power of the camera will not be turned off (→ P.14). Accordingly, even if you switch the camera off, stored preset positions, the date and the time are not cleared.
- Whenever possible, switch the camera off when it is not in use as this reduces power consumption. If the camera will not be used for an extended period, unplug the AC adapter from the wall outlet. If you turn the power off, the date and time will be cleared.

# Camera Settings

Set and display the clock and text, and specify camera operation settings.

## 1 Buttons Used to Specify the Settings

The wireless controller buttons shown below are used for the setting.

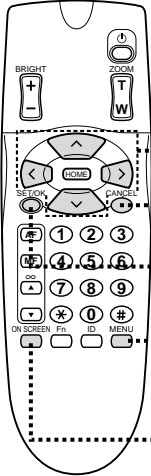

The diagram shows a wireless controller with the following buttons and their functions:

- Up and Down arrow buttons:** Move the cursor up and down.
- Right arrow button:** Moves the cursor right. Also proceeds to the next setting level.
- Left arrow button:** Moves the cursor left.
- CANCEL button:** Returns to the previous screen without confirming any settings.
- SET/OK button:** Confirms the settings and proceeds to the next setting level.
- MENU button:** Displays or hides the setting menu. While the setting menu is displayed, the LED on the camera blinks green (at 0.5-sec intervals).
- ON SCREEN button:** Displays or hides displays such as the clock and text (→ P.24). If no date or time is set, the date setting (01.JAN.'00) and time setting (00.00.00AM) blink. Note that this button is disabled when the camera is in the setting menu.

## Setting Menu Description

Press the  button to display the setting menu.

Cursor

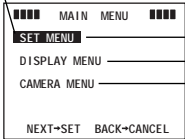

The screenshot shows the following menu structure:

- SET MENU:** Use this menu to specify the settings used to control the camera from a PC or another unit via the RS-232C input terminal (→ P.28).
- DISPLAY MENU:** Use this menu to set the clock and to enter the characters (→ P.23, 24).
- CAMERA MENU:** Use this menu to change the settings for camera head pan and tilt speed, the range of camera head movement, and the camera head brightness level (→ P.25–27).

## 2 Setting the Clock

Use the procedure below to set the date and time. You can also select your preferred TIME STYLE and DATE STYLE settings.

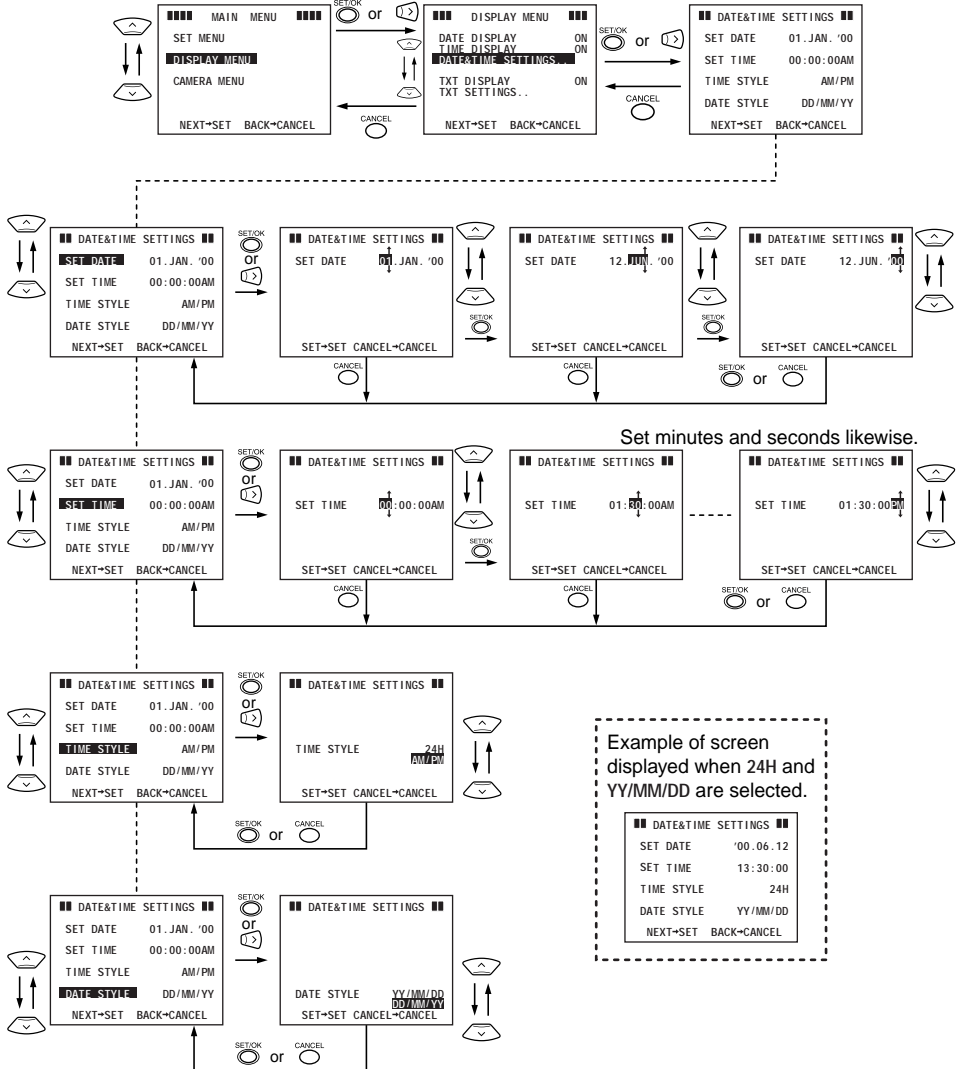

When you turn the power off (→ P.14), the specified date and time are cleared and the settings revert to the factory default settings (→ P.34). However, these settings are not cleared if you switch the camera off (→ P.21).

### 3 Entering Characters

The characters that can be specified are uppercase letters (A to Z), numbers (0 to 9) and some symbols (<, >, -, /, ,, : and spaces). Text can be entered anywhere on the screen outside the character area. Repeat steps ② and ③ in the procedure below for each character entered. If the text runs over multiple lines, repeat steps ① to ⑤ for each line. To delete a character, place the cursor over the ← (backspace) and press the button to delete the text one character at a time.

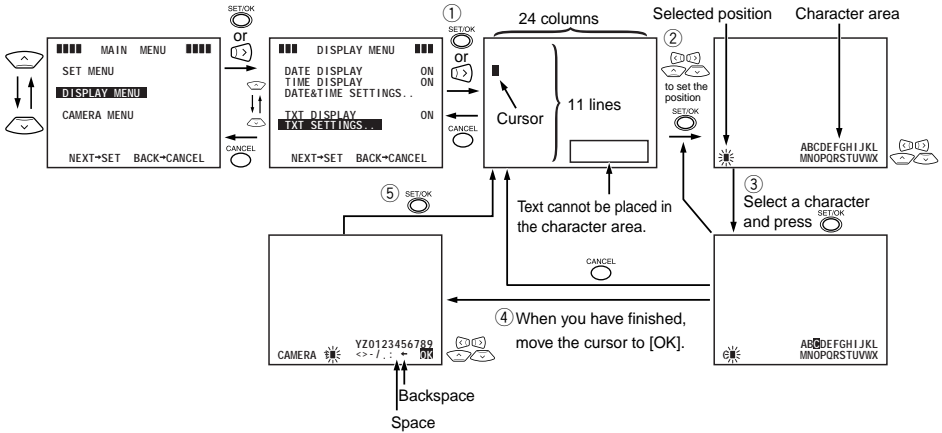

### 4 Selecting Display/Hide Clock and Text

Select ON to display the date, time and text, and select OFF to hide them. If you select ON, you can display and hide the date, time and text by pressing the button.

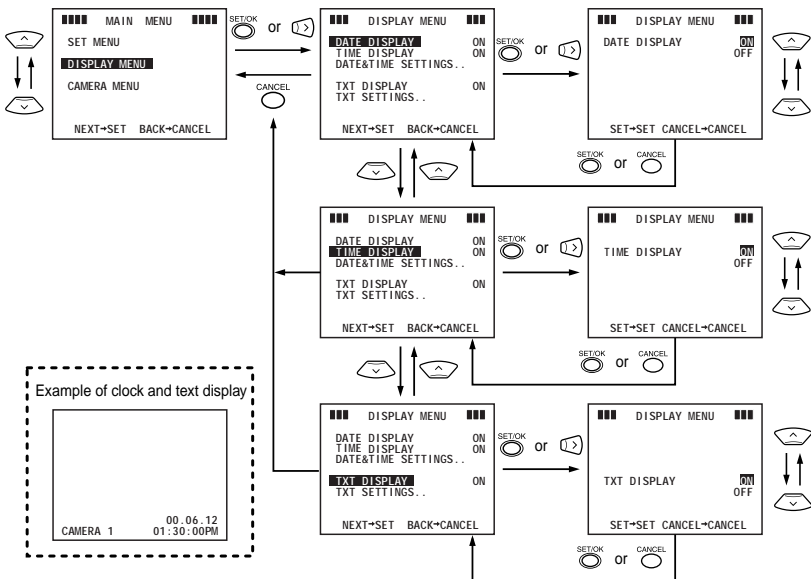



## 5 Setting the Camera Head Movement Speed and Pan Operation

Use the procedure below to set the speed at which the camera head pans and tilts and to select the DIRECTION MIRROR setting (direction of camera head panning).

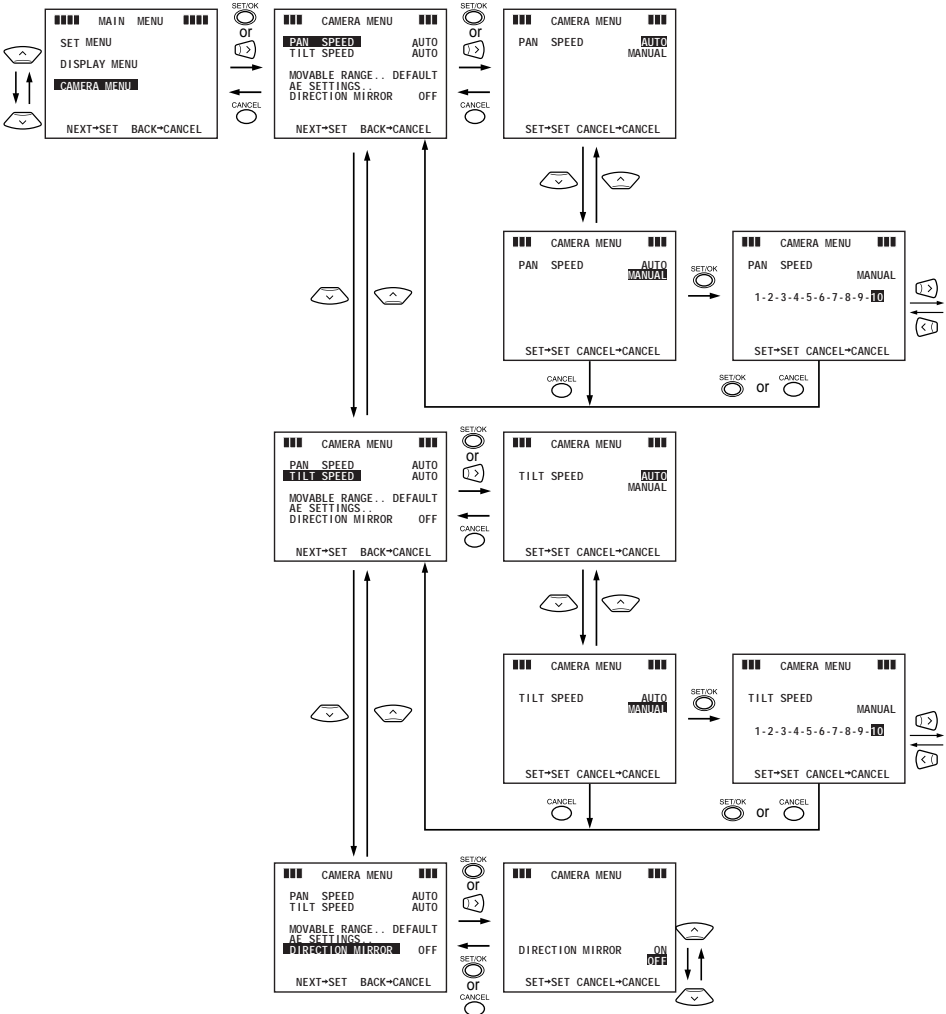

- If you set DIRECTION MIRROR to ON, the camera head pans in the direction indicated on the or button (→ P.16).
- The pan and tilt speeds set here are also used in preset position operations (→ P.20). And also if the “AUTO” setting is selected, the camera head moves at the maximum speed.

## 6 Setting the Range of Camera Head Movement

Use the procedure below to limit the range of camera pan and tilt (→ P.16). This feature allows you to watch the image on the monitor as you move the camera head to the position you want to set as the limit of movement.

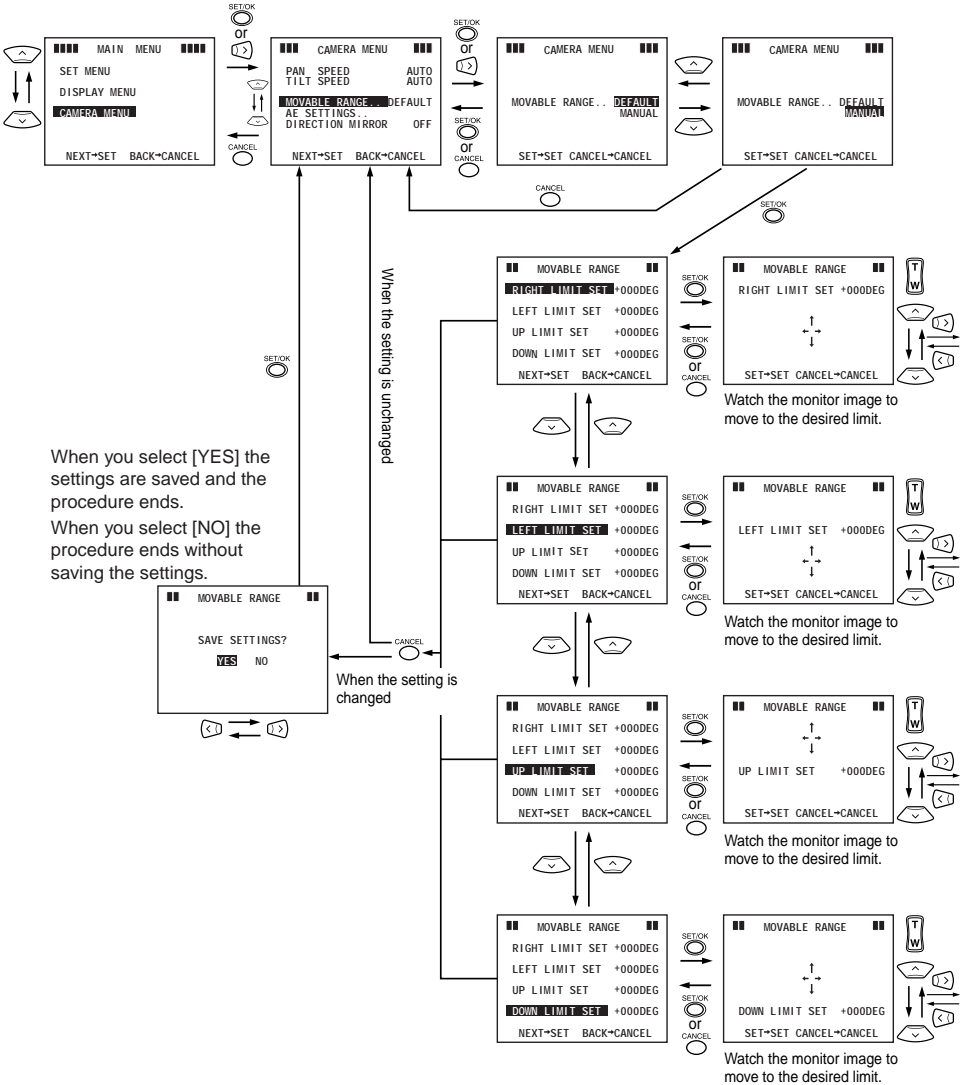

The limits for the range of camera head movement are as follows:  
 VC-C4: ±100° left and right, 90° upward and 30° downward  
 VC-C4R: ±170° left and right, 10° upward and 90° downward

## 7 Setting the AE

Use the procedure below to specify the AE (brightness adjustment) setting. FLICKERLESS AE is unnecessary to set.

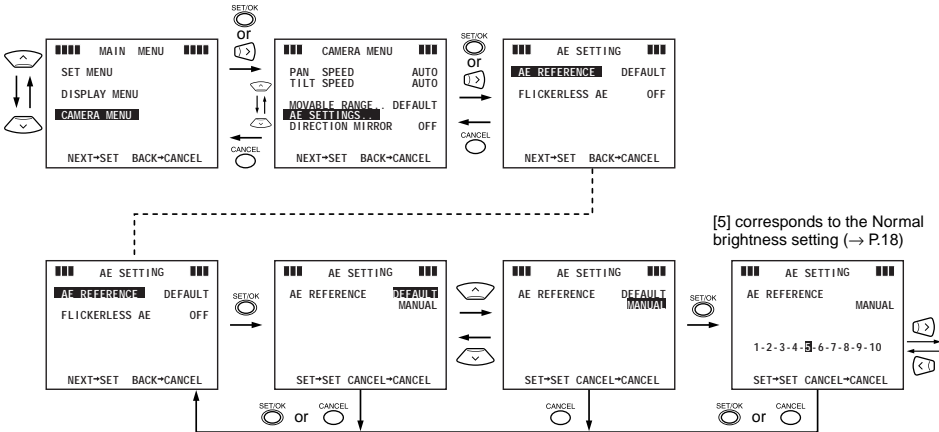

## 8 VC-C1 Mode and VC-C3 Mode Setting Menu

Use this procedure to set the COMMAND setting for using the VC-C4/VC-C4R in Canon Communication Camera VC-C1 mode or VC-C3 mode (→ P.28). When you set COMMAND to VC-C1 mode or VC-C3 mode, some of the setting menus and specifications change, as shown below.

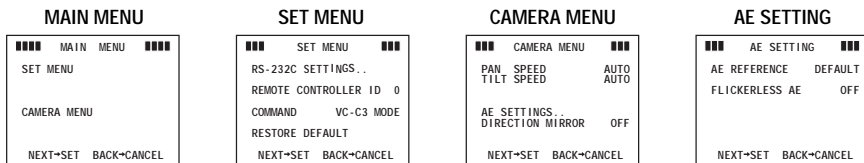

NOTE

- REMOTE CONTROLLER ID in the SET MENU and AE REFERENCE in the AE SETTING are only enabled in VC-C3 mode and do not appear in the VC-C1 mode.
- If you press the  button after changing the mode, the screen momentarily goes blank. This is not a fault. Also, when you change modes, all the stored preset positions are cleared and the range of camera head movement reverts to the default values in each mode.
- The range of pan/tilt/zoom movement in VC-C1 mode corresponds to that available on the VC-C1 itself.

## 9 RS-232C Settings

These settings are used for controlling the VC-C4/VC-C4R from a PC or other device. The DATA 8 BIT and NON PARITY settings are fixed, and the menu is used to check them only. DATA 8 BIT and NON PARITY are to be read only.

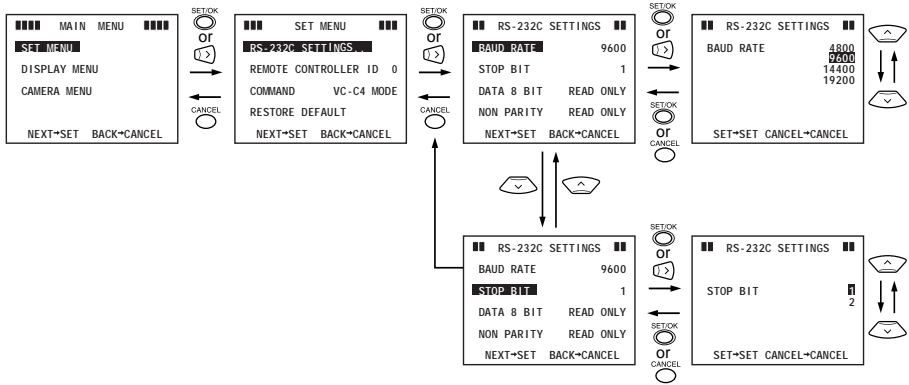

- See page 29 for information on the REMOTE CONTROLLER ID setting.
- COMMAND is used when the VC-C4/VC-C4R is used in Canon Communication Camera VC-C1 or VC-C3 mode (→ P.27).
- To restore the default values for the settings (→ P.34), select [SET] in the RESTORE DEFAULT setting.

# ID Mode

When multiple VC-C4/VC-C4R cameras are connected and installed, all the cameras in range of the wireless controller simultaneously perform the operations specified. In this situation, the cameras can be operated individually by assigning separate ID numbers to each camera beforehand and then specifying the desired ID number from the wireless controller. This is referred to as ID mode operation.

## 1 Setting the ID Number







Use the procedure below to assign an ID number (1-9) to each camera (VC-C4/VC-C4R). If you do not want to assign an ID number to a camera, select [0] for that camera. Assigning the same ID number to multiple cameras allows you to control those cameras simultaneously.

1. **Switch the power on to the cameras to which you want to assign the same ID number. Switch the power to the other connected cameras off.**

Switch the power to a camera off by unplugging the AC adapter connected to the camera (→ P.14). Even if you turn the power off, the ID number will not be cleared.

2. **Press the  button on the wireless controller to display the MAIN MENU screen.**

3. **Select REMOTE CONTROLLER ID in the SET MENU and set the ID number.**

Use the  and  buttons to move the cursor up and down, use the  button to confirm the selected setting and proceed to the next level, and use the  button to move back to the previous level without confirming the selected setting. Use the  and  buttons to change values.

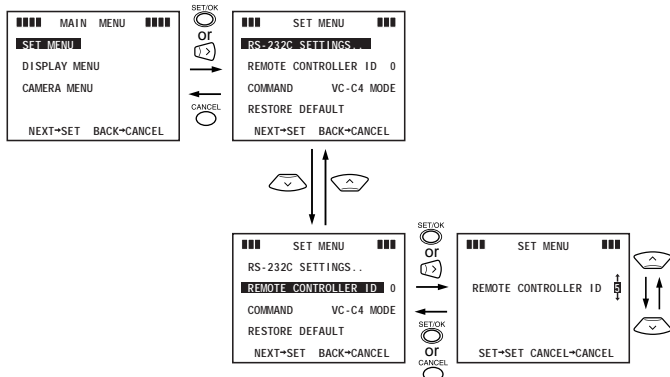
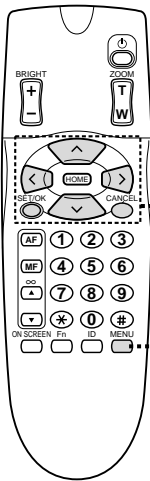



4. **When you have set the ID number, press the  button or  button to exit the settings screens.**

5. **Repeat Steps 1 to 4 until ID numbers are set for all the cameras.**

## 2 Selecting the Camera to be Controlled

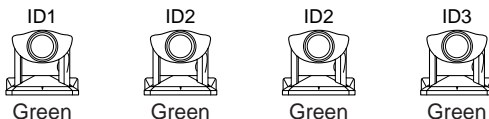
<Example> As shown in the figure below, of 4 cameras (ID1 to ID3) only the cameras with ID number 2 (2 cameras) are selected for ID mode operation. In normal operation, the camera LEDs turn green.



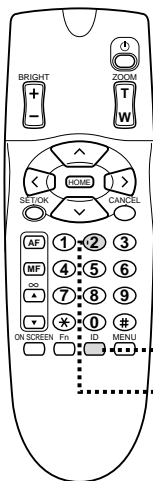

- Check the LEDs on all the adjacent connected cameras to ensure that all the cameras are receiving the signals from the wireless controller.
- Even if the cameras are switched off, when you press the  button the LEDs on all the cameras blink orange and you can begin ID mode operation. However, when a number button was pressed in step 2, the LEDs on cameras with ID numbers that do not match or that have not been assigned an ID number turn red and those cameras are switched off.

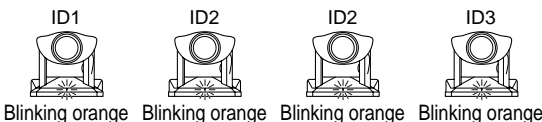

### 1. Press the button.

The LEDs on all the connected cameras blink orange (at 0.5-second intervals).



To cancel ID mode operation, press the  or  button. The LEDs on all the cameras then turn green.

### 2. Press a number button (in this case ②).

The cameras with ID2 are selected and the LEDs on only those cameras turn green. The LEDs on the other cameras turn orange (not blinking).

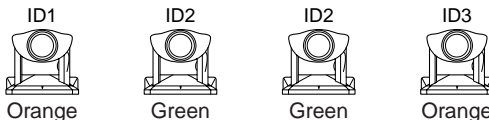

This completes the selection procedure. When you use the wireless controller, only the selected cameras will respond. When you press a button on the wireless controller, the LEDs on the selected cameras blink green (at 0.1-second intervals) and the LEDs on the other cameras blink orange (at 0.1-second intervals).

### 3 Cancelling ID Mode

<Example> In this example, the selection made in the previous section of the cameras with ID number 2 is cancelled. The camera LEDs are as shown below.

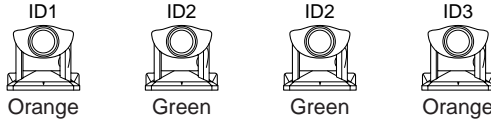

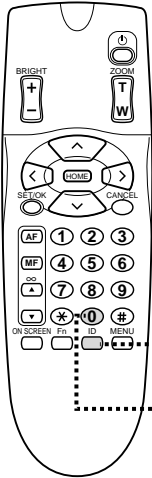

Check the LEDs on all the adjacent connected cameras to ensure that all the cameras are receiving the signals from the wireless controller.

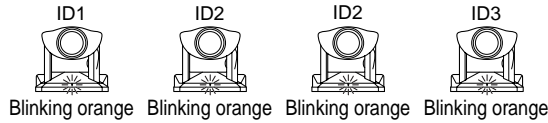

#### 1. Press the ID button.

The LEDs on all the connected cameras blink orange (at 0.5-second intervals).



To cancel ID mode operation, press the  or  button. The LEDs on all the ID2 cameras turn green and the LEDs on the other cameras turn orange.

#### 2. Press the 0 button.

The LEDs on all the cameras turn green as for normal operation.

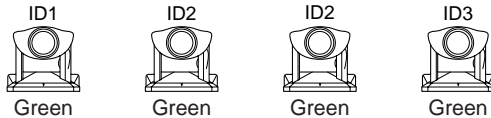

This completes ID mode cancellation. All the cameras will now respond simultaneously to the signals from the wireless controller.

# Troubleshooting

Check the following before contacting your Canon supplier.

## The wireless controller does not work.

**Check 1: The LED is not lit.**

**Response:** Check that the plug is inserted into the main power outlet correctly and pushed in all the way. → **P.14**

**Check 2: The LED is red.**

**Response:** The camera is switched off. Press the  button on the wireless controller to switch the camera on. → **P.21**

**Check 3: The LED is orange.**

**Response:** Operation is restricted by the ID mode function. Reset the ID correctly or cancel ID mode operation. → **P.29–31**

**Check 4: The LED is green.**

**Response:**

- Check the remaining charge in the wireless controller batteries.
- Ensure that you are using the wireless controller inside its effective range.

→ **P.15**

## There is no picture on the monitor.

**Check 1: The LED is red.**

**Response:** The camera is switched off. Press the  button on the wireless controller to switch the camera on. → **P.21**

**Check 2: The components are not all connected correctly.**

**Response:** Check that the components are all connected correctly. → **P.13**

**Check 3: Power to the camera or monitor is not switched on.**

**Response:** Turn power on for the camera and monitor. → **P.14**

## Cannot adjust the camera head angle properly.

**Check 1: The camera head will not move to the limit of its range of movement.**

**Response:** Something has directly moved the camera head. Press the  button on the wireless controller. → **P.16**

**Check 2: Restrictions have been applied to the range of camera head movement.**

**Response:** Change the range of camera head movement. → **P.26**



## The camera will not move to a preset position.

**Check 1:** The camera head will not move to the limit of its range of movement.

**Response:** *Something has directly moved the camera head. Press the **HOME** button on the wireless controller. → P.16*

**Check 2:** The range of pan/tilt movement has been changed since the preset position was stored.

**Response:** *Store the preset position again. → P.20*

## The camera will not focus.

**Check 1:** The camera is set to manual focus mode.

**Response:** *Focus the camera manually or press the **(AF)** button on the wireless controller to switch to auto-focus. → P.18–19*

**Check 2:** The lens is dirty.

**Response:** *Clean the lens. → P.8*

**Check 3:** You restored a preset position.

**Response:** *If a preset position is restored when the camera is in manual focus mode, the camera may be out of focus once it has moved to the preset position. Adjust the focus manually or press the **(AF)** button on the wireless controller to switch to auto-focus. → P.18–19*

**Check 4:** The distance between the subject and the camera is not within the camera's focal range.

**Response:** *Depending on the zoom position, the camera may not be able to focus at some distances regardless of whether it is in auto-focus or manual focus mode. Adjust the distance between the camera and the subject. → P.17*

**Check 5:** You are using auto-focus mode to photograph a subject that is not suitable for auto-focus mode (→ P.18).

**Response:** *Adjust the focus manually. → P.19*

# Factory Default Settings

When the Product is shipped from the factory or when RESTORE DEFAULT has been set to [YES] (→ P.28), the settings are set to the default values shown below.

## (Camera Default Settings)

Item	Default	Item	Default
Focus *	Auto	Preset	None
Brightness *	Normal	Clock and Text	Not displayed

## (Setting Screen Default Settings)

Item		Setting
SET MENU	BAUD RATE	9600
	STOP BIT	1
	DATA 8 BIT	Read only
	NON PARITY	Read only
	REMOTE CONTROLLER ID	0
	COMMAND	VC-C4 MODE
DISPLAY MENU	DATE DISPLAY	ON
	TIME DISPLAY	ON
	TXT DISPLAY	ON
	SET DATE *	01.JAN.'00
	SET TIME *	00:00:00AM
	TIME STYLE *	AM/PM
	DATE STYLE *	DD/MM/YY
	Specified text *	None
CAMERA MENU	PAN SPEED	AUTO (10 for MANUAL)
	TILT SPEED	AUTO (10 for MANUAL)
	MOVABLE RANGE	DEFAULT
	DIRECTION MIRROR	OFF
	AE REFERENCE	DEFAULT (5 for MANUAL)
	FLICKERLESS AE	OFF

\* Settings marked with an asterisk revert to the factory default values when the power is switched off and then on again (→ P.14). The values for all other settings are saved when the power is turned off.

# Specifications

Item		Details
<b>Video Signal</b>		Conforms to NTSC color format for USA, Canada Conforms to PAL color format for Europe, Asia, Oceania
<b>Image Sensor</b>		1/4-inch CCD
<b>Total number of pixels</b>		NTSC: 410,000 (380,000 effective) pixels PAL: 470,000 (440,000 effective) pixels
<b>Synchronization</b>		Internal
<b>Horizontal Resolution</b>		NTSC: 460 TV lines PAL: 420 TV lines
<b>Vertical Resolution</b>		350 TV lines
<b>S/N Ratio</b>		48 dB
<b>Scanning Method</b>		2:1 interlaced
<b>Min. subject illumination</b>		6 lux
<b>Drive Mechanism</b>		VC-C4 Pan Mechanism: Rotation angle Left 100°, Right 100°; Rotation speed: 1°-90° per sec.* Tilt Mechanism: Tilt angle Up 90° (factory default 30°), Down 30°; Tilt speed: 1°-70° per sec.
		VC-C4R Pan Mechanism: Rotation angle Left 170°, Right 170°; Rotation speed: 1°-90° per sec.* Tilt Mechanism: Tilt angle Up 10°, Down 90°; Tilt speed: 1°-70° per sec.
<b>Output Terminals</b>		VIDEO OUT: 1 RCA pin jack (output impedance approx. 75 Ω) S VIDEO OUT: 1 mini-DIN 4-pin socket (output impedance approx. 75 Ω)
<b>Input Terminal</b>		RS-232C: 2 mini-DIN 8-pin sockets (input and output)
<b>Cascade control</b>		Up to 9 cameras
<b>Focusing</b>		Auto/Manual
<b>Aperture</b>		Auto iris servo system
<b>Lens</b>		Focal length 4.0 to 64.0 mm, f/1.4 to f/2.8, 16× power zoom
<b>Lens filter diameter</b>		37 mm (1 15/32 in.), pitch=0.35 mm (1/64 in.)
<b>White Balance</b>		TTL-system full-auto white balance
<b>Power Supply terminal</b>		DC IN. Rated 13 V (Permissible range 11.5 V to 14 V) (EIAJ RC-5320A, 4 voltage sections)
<b>Max. Power Consumption</b>		Approx. 12 W; approx. 5 W with camera switched off (including AC power adapter)
<b>Operating Environment</b>		Temp.: 0°C to 40°C (32°F to 104°F); Humidity: 20-85% RH (no condensation)
<b>Installation Angle</b>		±20° from horizontal (±15° with optional wide-angle converter installed)
<b>Dimensions</b>		100 × 112 × 89.5 mm (3 15/16 × 4 7/16 × 3 17/32 in.) (W × D × H) (excluding attachments)
<b>Weight</b>		VC-C4: Approx. 375 g (Approx. 0.83 lb.) / VC-C4R: Approx. 435 g (Approx. 0.96 lb.)
<b>Wireless Controller</b>	<b>Model</b>	WL-V5
	<b>System</b>	Infrared pulse system
	<b>Power Supply</b>	3 V DC (2 AA-type batteries)
	<b>Dimensions</b>	50 × 175 × 24.5 mm (1 31/32 × 6 29/32 × 31/32 in.) (W × D × H) (excluding attachments)
	<b>Weight</b>	Approx. 79 g (Approx. 0.17 lb.) (excluding batteries)
<b>AC Adapter</b>	<b>Model</b>	PA-V16
	<b>Input</b>	100-240 V AC, 50/60 Hz, 50-65 VA
	<b>Output</b>	13 V DC, 1.8 A (max.)
	<b>Polarity</b>	External (-), Internal (+)
	<b>Dimensions</b>	58 × 118 × 25 mm (2 5/16 × 4 21/32 × 1 in.) (W × D × H) (excluding attachments)
	<b>Weight</b>	Approx. 205 g (Approx. 0.45 lb.)

\* If you are using a computer to control the camera, the image on the screen may appear shaky when the camera head is being moved slowly.

- These specifications are subject to change without notice.
- For the AC adapter, use the PA-V16 dedicated unit. Also, do not use the PA-V16 AC adapter with any other product.

# Appendix A (serial pin outs and bit rate setting)

## RS-232C Pin Out Diagrams

### 9pin DSUB to 8pin mini-DIN (VC-C4/VC-C4R) Connection

Below is a cable pin out of the cable required to control this equipment from a computer with a 9pin control port.

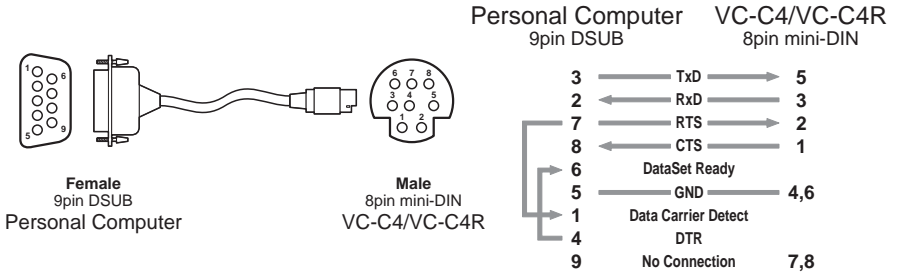

### 8pin mini-DIN to 8pin mini-DIN (VC-C4/VC-C4R) Connection

Below is a cable pin out of the cable required to control this equipment from a computer with a 8pin control port.

